

MODEL : FT70

RATIO : 2.3.4.5 (單段 1-Stage)

FT

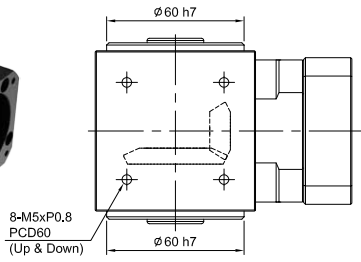

FT-FO

入力法蘭 - 出力中空軸

Input Flange

- Hollow Output Shaft

unit:mm	
Model Code	70
A1	14
A2	50 · 60 · 70
A3	M4 · M5 · M6
A4	70 · 75 · 90
A5	64 · 70 · 80
A6	M5 x P0.8
Weight ±3% (kg)	1.47

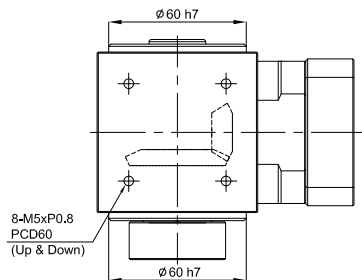
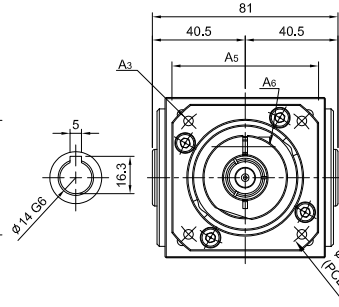
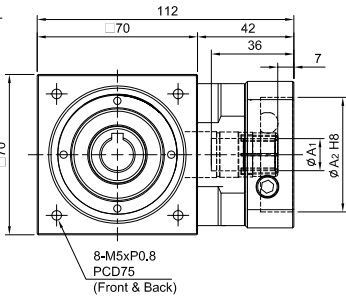
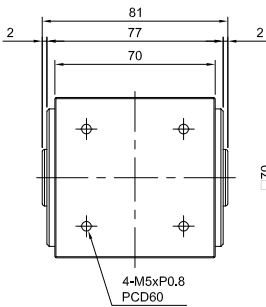

FT-FP

入力法蘭 - 出力盤式

Input Flange - Fixing Flange

unit:mm	
Model Code	70
A1	14
A2	50 · 60 · 70
A3	M4 · M5 · M6
A4	70 · 75 · 90
A5	64 · 70 · 80
A6	M5 x P0.8
Weight ±3% (kg)	1.75

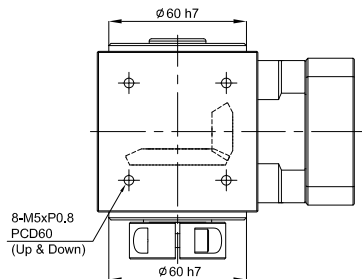
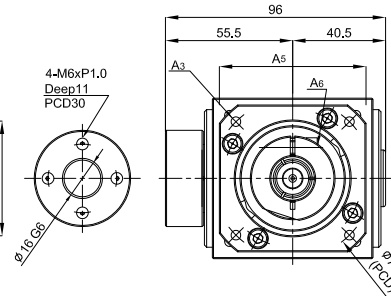
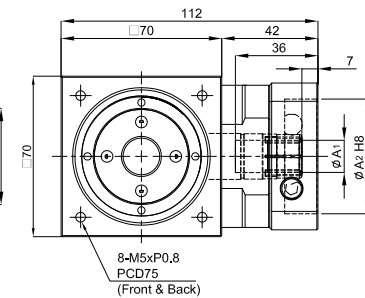
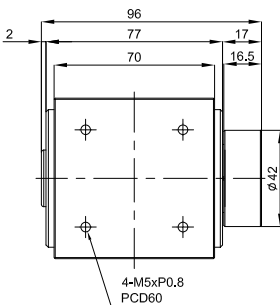

FT-FC

入力法蘭 - 出力迫緊環

Input Flange - Set Collar

unit:mm	
Model Code	70
Weight ±3% (kg)	1.6

